



Helpful Hints to Basic Welding



This guide, and all the information contained within, is intended to provide you with helpful hints for basic welding. It is not intended as a comprehensive manual, nor does it contain the scope of information needed for commercial or industrial welding purposes.

If you are not familiar with the safety practices, procedures and techniques of basic welding, you will need to supplement this guide with additional reading material and/or enroll in a basic welding course.

For any welding that involves the protection of life, limb or property, always seek the services of a competent professional welder.

Everyday Welding Applications	2
Welding Safety	3
Stick or Wire: Which is Your Welding Preference?	4
Basic Stick Welding – A Quick Review	5
Stick Electrodes	5
Equipment and Tools	6
Techniques	6
Setting the Amperage	7
Striking an Arc	7
Electrode Angles	8
Arc Length	8
Travel Speed	9
7 Factors in Selecting Arc Welding Electrodes	9
Filler Metals Selector Guide	10
Examples of Good and Bad Stick Welds	12
Wire Welding – A Quick Review	14
Wire Electrodes	14
Equipment and Tools	15
Techniques	15
Wire Polarity	16
Wire Feed Speed and Voltage	16
Initiating an Arc	17
Electrode Stick-Out	17
Electrode Angles	17
Welding Gun Manipulation	18
Travel Speed	19
Shielding Gases and Their Welding Advantages	19
Examples of Good and Bad Wire Welds	20

EVERYDAY WELDING APPLICATIONS

Welding is an efficient and easy way to cut down on maintenance or repair costs associated with metal equipment around the house or farm. Through welding, you can repair a wide variety of things including:



Harrow disk repair with Hobart 335A stick electrodes



Four-wheeler repair with Hobart's HB-28 solid wire

Home Improvement

- Lawnmower decks and handles
- Ductwork
- Fencing
- Steel patio furniture
- Garage door tracks and brackets
- Wheelbarrows

Recreation

- Basketball rims and posts
- Swing sets
- Trampolines
- Wagons
- Snowmobile skis and skags
- Bicycles and tricycles

Agricultural

- Combines
- Grain wagons
- Balers
- Farm equipment frames
- Tractors and trailers
- Galvanized roofing
- Trailer hitches
- Trailer frames and sides

Automotive

- Tailpipes
- Motorcycles
- Bumpers
- Trailer hitches
- Auto bodies and door brackets

Helpful Hint #1

Before starting any welding project, be sure you read about welding safety!

WELDING SAFETY

Always remember... **welding is serious business!** Make sure you protect yourself by following these important safety tips:

Always wear protective clothing!

Wear a heavy cotton shirt, cuffless trousers, high shoes and a cap to protect yourself while welding or removing slag.

Always wear a welding helmet with visor shade #10 or darker!

Arc rays from the welding process produce intense visible and invisible (ultraviolet and infrared) rays that can burn eyes and skin. **NEVER WELD WITHOUT PROPER EYE PROTECTION!**



Always wear safety glasses!

Wear safety glasses with side shields to protect your eyes while welding and removing slag.

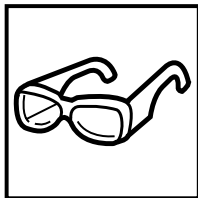

Always wear leather welding gloves!

Wear gloves to protect your hands and wrists from hot sparks and radiation burns while welding and removing slag.



Weld in a well-ventilated area... fumes and gases can be hazardous!

Welding may produce fumes and gases that can make you ill. Be sure to keep your head out of the fumes – do not breathe the fumes!

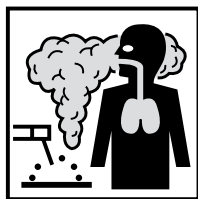

Keep weld area free of flammables!

Move paint, solvent, gasoline, paper products and other flammables away from the weld area so they won't catch fire from sparks and hot slag.



Protect others!

Set up protective screens or barriers to protect other persons from flash and glare; warn others not to watch the arc.



When welding small parts, do not weld on the garage floor or driveway... use a welding table!

The heat generated by the electric arc can cause cement to explode or set asphalt on fire.

Do not weld on tanks or containers that previously held flammable materials!

Even though it may be empty, a tank or container that previously held a flammable material may still contain combustible vapors or residue that can result in an explosion.

Be familiar with your welding equipment!

Understanding how to properly operate welding equipment protects you from harm and your equipment from damage.

Helpful Hint #2

To learn more about basic welding, call the Hobart Institute of Welding Technology!

For course information, call 937.332.5000 or 800.332.9448, or visit their web site at www.welding.org

STICK OR WIRE: WHICH IS YOUR WELDING PREFERENCE?

There are several different welding processes that are ideal for projects around the house of farm:

- **Stick welding** – properly known as SMAW (Shielded Metal Arc Welding)
- **Wire welding** – properly known as GMAW (Gas Metal Arc Welding) or FCAW (Flux-cored Arc Welding)

All of these processes involve the joining of metals by means of an electric arc. This electric arc, at a temperature of about 10,000°F, melts both the metal electrode and the base metal (the metal being welded) together, producing a molten weld puddle that quickly solidifies to form the weld.

STICK WELDING

Although these processes depend on the use of an electric arc, they differ in technique, including the type of electrode and equipment required. Stick welding is a manual arc welding process in which a covered metal stick electrode is used as the filler metal for making the weld. Wire welding is considered as a semi-automatic process, using a wire electrode that's conveniently fed through a welding gun.



Front-end loader repair with Hobart 18AC stick electrode

Stick welding requires you to have more skill because you have to consistently concentrate on the electrode while you are welding, keeping it in the proper welding position and manually maintaining the proper arc length as the electrode gets shorter.



Repairing farm equipment using Hobart's Champion and 418 stick electrodes.

Wire welding is considered to be somewhat easier than stick welding because the welding gun continuously feeds the wire while you weld, allowing you to focus on gun position for maintaining the proper arc length. Plus, you don't have to worry about the electrode getting shorter.

Whether you prefer stick welding or wire welding... the welding process you use is most likely the one you have the most experience with or have the equipment for.

Stick welding (properly known as Shielded Metal Arc Welding or SMAW) requires use of a covered stick electrode, a metal rod that's coated with a material called flux. An electrode holder is used to hold and supply current to the stick electrode, causing it to melt and deposit molten metal. As the electrode melts, the flux coating breaks down to perform several functions: 1) form a gas shielding

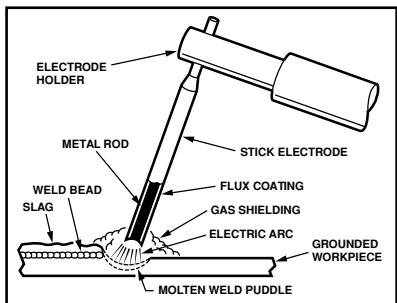



5-lb. Plastic Paks of Hobart stick electrodes

to protect the weld puddle from the air, 2) keep the weld puddle clean from contaminants, and 3) produce a light, protective coating, called slag, over the weld. The slag is removed by tapping the weld with a chipping hammer or chisel and cleaned off with a wire brush.

Stick electrodes ideal for various home and farm welding projects include Hobart's 335A, 18AC, 418 and 447A. These premium stick electrodes are great for many different applications and come in a variety of diameter sizes. For a list of product applications, see pages 10-11.

Equipment and Tools

In stick welding, the equipment and tools that are required are:

- power source welding machine – complete with welding cable, electrode holder and ground cable and clamp
- chipping hammer or chisel, and a wire brush (for removing slag)
- protective clothing including helmet and gloves



Repairing farm fencing in the field using Hobart's 418 stick electrodes

Helpful Hint #3

If you have to use an extension cord to get power to your welding equipment, make sure the cord is the correct size to carry the current from the outlet to the power supply!



Great for many applications, Hobart 18AC features a smooth, stable arc and offers excellent re-striking capabilities.

Techniques

To produce a good quality weld, it is important to master the following stick welding techniques. The first thing you should do before you start welding is make sure the workpiece – the item you are welding – is as clean as possible. Use a clean cloth, wire brush or sandpaper to remove any rust, dirt, paint, grease, oil or other contaminant. Do not use cleaning solvents because you can run the risk of an explosion or fire, or illness from toxic vapors.

Helpful Hint #4

Be sure to connect the ground clamp of your welding equipment to the workpiece before you start welding!

Setting the Amperage

Select the proper amperage based on the specifications of the stick electrode. Sometimes, you may find that you have to “fine tune” the setting so that the electrode melts properly. The best way to check this is to perform some test welds on some scrap metal and look at the weld. If you notice that the weld is...

- piling up or you see signs of burn-through (holes in the base metal), then the amperage is probably set too high;
- not penetrating the joint (little depth) or not fusing to the workpiece (doesn't cover joint walls) properly, then the amperage is probably set too low.

Striking an Arc

To strike an electric arc, bring the tip of the stick electrode near where you want to start the weld. Almost like striking a match, strike the stick electrode slightly across the workpiece until you have established an arc.

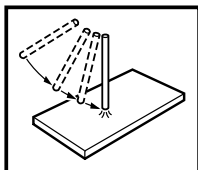

Once you have an arc, be sure to keep the electrode slightly above the workpiece, otherwise it will stick and you will have to break the electrode free of the workpiece. If you have trouble striking an arc, you may be lifting the electrode too high off of the workpiece, causing the arc to go out.

The most important thing you want to do after you've initiated the arc is to maintain proper position of the electrode and arc. This involves three key factors, namely:

- electrode angles
- arc length
- travel speed

Helpful Hint #5

Position the ground clamp on the workpiece so that you will be welding away from the clamp. This will help keep arc blow (interference from magnetic fields) to a minimum when using DC current.

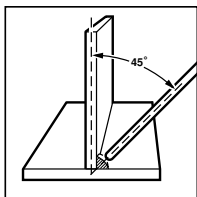

Electrode Angles

Electrode angles are the angles at which you should hold the stick electrode in relation to the workpiece while welding. These angles differ depending on the type of weld you intend to make.

For instance, when doing a lap weld (one piece of metal overlaps another) or a T-weld (joining two metals to form a 'T'), hold the electrode so that it points into the weld joint at an angle of 45°. When you start welding, angle it 10-15° toward the direction of travel until you complete the weld and terminate the arc.

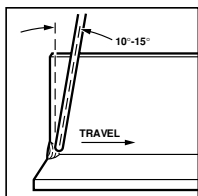

T-weld with 45° work angle and 10°-15° travel angle

For butt weld (joining two pieces of metal butted together), first hold the electrode so that it is pointing into the joint of the workpiece at an angle of 90°. Then, as you start welding, angle the electrode so that it is pointing 10-15° in the direction of travel (see illustrations above). When completing the weld, bring the electrode back to 90° and lift it to terminate the arc.

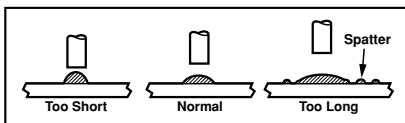

Arc lengths

Arc Length

Maintaining the proper arc length is another key factor in producing a good quality weld. The arc length is the

distance from the end of the stick electrode to the surface of the molten weld puddle. Be careful to watch the stick electrode as you weld because as it becomes shorter and shorter, you have to keep moving the electrode toward the weld joint to maintain the proper arc length.

A good rule of thumb to follow is: try to keep the end of the electrode at a distance from the joint that's approximately equal to the diameter of the stick electrode. For example, if the stick electrode you are using is 1/8" in diameter, then keep the end of the electrode about 1/8" from the molten weld puddle.

Keep in mind that an arc length that is too long makes a coarse, uneven cracking sound that will often go out. You will also see an excessive amount of spatter (metal particles outside the weld) and the weld will be too wide.

A short arc makes a soft buzzing noise and produces a weld that is too narrow. In some cases, the stick electrode will stick to the workpiece. If this happens, move the stick electrode side to side and pull it to free it from the workpiece.

Helpful Hint #6

Arc re-starts are much more effective when the flux covering at the end of the stick electrode is flush with the metal rod.

Travel Speed

Travel speed is the rate at which you weld. A good travel speed produces a uniform weld that is slightly convex in appearance. However, if you travel too slow, the weld will pile up, wasting filler metal. If you go too fast, the weld will be narrow and lack proper penetration and fusion.

Helpful Hint #7

For examples of good and bad welds, along with descriptions and illustrations of common stick welding defects, see pages 12-13.

7 FACTORS TO CONSIDER IN SELECTING ARC WELDING ELECTRODES

1. Base Metal Strength Properties

Know and match mechanical properties. Mild steel – generally E-60XX or E-70XX electrodes match base metal. Low alloy steel – select electrodes that match base metal properties.

2. Base Metal Composition

Know and match composition. Mild steel – any E-60XX or E-70XX electrode is satisfactory. Low alloy steel – select electrode that most closely matches base metal composition.

3. Welding Position

Match electrode to welding position encountered.

4. Welding Current

Match the power supply available. Some electrodes are designed for direct current (DC); others, alternating current (AC); some, either. Observe correct polarity.

5. Joint Design and Fit-up

Select for penetration characteristic – digging, medium, or light. No beveling or tight fit-up – use digging. Thin material or wide root opening – light, soft arc.

6. Thickness and Shape of Base Metal

To avoid weld cracking on thick and heavy material of complicated design, select electrode with maximum ductility. Low hydrogen processes or electrodes are recommended.

7. Service Condition and/or Specifications

Determine service conditions – low temperature, high temperature, shock loading – match base metal composition, ductility and impact resistance. Use low hydrogen process. Also, check welding procedure or specification for electrode type.

	Application	Thickness	Stick Electrode/Dia/Amps
AUTOMOTIVE	Auto Body	.022"	N/A
	Auto Door Brackets	3/64"	335A/3/32" / 50-100
	Axles	3/16"-1/4"	18AC or 418/ 1/8" /90-145
	Bumpers	1/8"	18AC or 418/ 1/8" /90-145
	Motorcycles	1/16"	18AC or 418/ 3/32" /80-100
	Tailpipes	3/64"	447A/ 3/32" /40-85
	Trailer Hitches	1/4"	18AC or 418/ 1/8" /90-145
	Trailer Frames	1/8"-1/4"	18AC or 418/ 1/8" /90-150
	Trailer Sides	1/16"	447A/ 3/32" /40-85
	Trailers	1/8"-1/4"	18AC or 418/ 1/8" /90-150
AGRICULTURAL	Balers	1/8"-3/8"	18AC or 418/ 1/8" /90-145
	Combines	1/16"-1/8"	18AC or 418/ 1/8" /90-145
	Farm Equipment Frames	3/16"-1/2"	18AC or 418/ 1/8" /90-145
	Galvanized Roofing	3/64"	335A/ 3/32" /50-100
	Grain Wagons	1/8"-3/8"	18AC or 418/ 1/8" /90-145
	Lawnmower Decks	1/16"-1/8"	335A/ 3/32" /50-100
	Lawnmower Handles	3/64"	447A/ 3/32" /40-60
Wheelbarrows	1/16"	447A/ 3/32" /40-85	
HOME IMPROVEMENT	Ductwork	.022"	N/A
	Fencing	1/8"	335A/ 3/32" /50-100
	Garage Door Tracks	1/16"	447A/ 3/32" /40-85
	Garage Door Brackets	1/8"	18AC or 418/ 3/32" /40-90
	Steel Patio Furniture	1/8"-1/4"	18AC or 418/ 3/32" /50-90
	Basketball Brackets	1/8"-3/8"	18AC or 418/ 1/8" /90-145
RECREATIONAL	Basketball Posts	1/16"-	335A/ 3/32" /50-100
	Basketball Rims	1/8"-3/8"	18AC or 418/ 1/8" /90-145
	Bicycles	3/64"	447A/ 3/32" /40-60
	Snowmobile Skis & Skags	1/8"-3/8"	18AC or 418/ 3/32" /50-90
	Swing Sets	1/16"	447A/ 3/32" /40-85
	Trampolines	1/16"	447A/ 3/32" /40-85
	Tricycles	3/64"	447A/ 3/32" /40-60
	Wagons	1/16"	447A/ 3/32" /40-85
GENERAL	Angle Iron	1/8"-3/8"	18AC or 418/ 1/8" /90-145
	Sheet Metal	.022"-1/8"	447A/ 3/32" /40-85

Flux-Cored Wire/Dia/Amps

Solid Wire/Dia/Amps

Fabshield 21B/.030"/30-85

HB-28/.024"/25-50

Fabshield 21B/.035"/50-100

HB-28/.035"/70-100

N/A

HB-28/.035"/80-200

N/A

HB-28/.035"/80-200

N/A

HB-28/.035"/80-110

Fabshield 21B/.035"/30-85

HB-28/.030"/70-100

N/A

HB-28/.035"/80-200

N/A

HB-28/.035"/80-200

Fabshield 21B/.035"/50-100

HB-28/.035"/80-110

N/A

HB-28/.035"/80-200

Fabshield 21B/.045"/80-180

HB-28/.035"/80-200

Fabshield 21B/.035"/30-150

HB-28/.035"/80-150

N/A

HB-28/.035"/80-200

Fabshield 21B/.030"/30-100

HB-28/.030"/70-100

Fabshield 21B/.045"/80-180

HB-28/.035"/80-200

Fabshield 21B/.045"/80-150

HB-28/.035"/80-150

Fabshield 21B/.030"/30-100

HB-28/.030"/70-100

Fabshield 21B/.035"/50-100

HB-28/.035"/80-1100

Fabshield 21B/.030"/30-85

HB-28/.024"/25-50

Fabshield 21B/.045"/80-180

HB-28/.035"/80-200

Fabshield 21B/.035"/50-100

HB-28/.035"/70-100

Fabshield 21B/.035"/50-150

HB-28/.035"/80-110

Fabshield 21B/.045"/80-180

HB-28/.035"/80-200

Fabshield 21B/.045"/80-180

HB-28/.035"/80-200

Fabshield 21B/.035"/50-200

HB-28/.035"/80-150

Fabshield 21B/.045"/80-180

HB-28/.035"/80-200

Fabshield 21B/.030"/30-100

HB-28/.030"/70-100

Fabshield 21B/.035"/50-150

HB-28/.035"/80-200

Fabshield 21B/.035"/50-150

HB-28/.035"/80-110

Fabshield 21B/.035"/50-150

HB-28/.035"/80-110

Fabshield 21B/.030"/30-100

HB-28/.030"/70-100

Fabshield 21B/.035"/50-150

HB-28/.035"/80-110

Fabshield 21B/.045"/80-180

HB-28/.035"/80-200

Fabshield 21B/.030"/50-150

HB-28/.024"/25-110

AUTOMOTIVE

AGRICULTURAL

HOME IMPROVEMENT

RECREATIONAL

GENERAL

EXAMPLES OF GOOD AND BAD STICK WELDS

GOOD WELD
Proper voltage
and travel speed

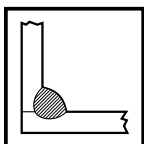

CROSS-SECTION

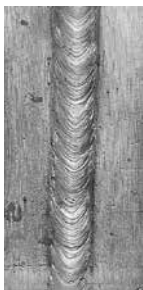

Weld Face

Smooth and well-formed

Uniform contour

Good penetration and fusion

BAD WELD
Welding current
too low

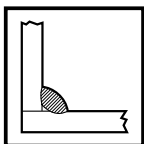

CROSS-SECTION



Weld Face

Narrow and convex

Irregular contour

Poor penetration and fusion

BAD WELD
Welding current
too high

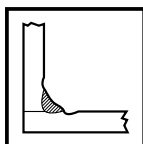

CROSS-SECTION



Weld Face

Wide and flat with excessive spatter

Very irregular contour

Undercutting along edges

BAD WELD
Travel speed
too fast

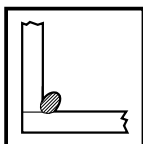

CROSS-SECTION



Weld Face

Narrow and convex

Irregular contour

Poor penetration and fusion

BAD WELD
Travel speed
too slow

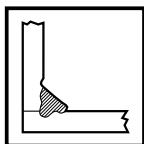

CROSS-SECTION



Weld Face

Excessively wide and flat, porous

Irregular contour

Excessive penetration along edges

WIRE WELDING – A QUICK REVIEW



Welding fabrication using the Hobart Ironman 250 with Hobart HB-28 solid wire

Wire welding is a semi-automatic process in which a continuous wire electrode is automatically fed through a welding gun. By simply positioning the gun near the workpiece and depressing the trigger, you can initiate an arc and maintain the automatic feeding of the wire electrode while you weld until you release the trigger.

Among the many types of wire electrodes available on the market, the two best suited for home and farm welding are solid wire electrodes and flux-cored wire electrodes. If you use a solid wire electrode, then you are doing what is known as MIG welding (properly known as gas metal arc welding or GMAW). If you use a flux-cored wire electrode, then you are doing flux-cored welding (also called flux-cored arc welding or FCAW).



2-lb. spool of Hobart's HB-28 solid wire



10-lb. spool box of Hobart's Fabshield 21B flux-cored wire

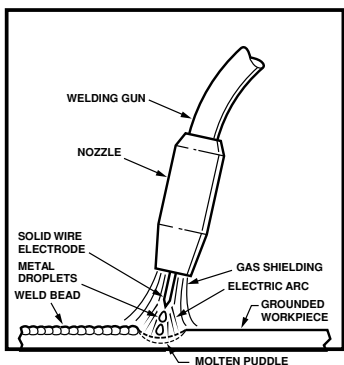

carbon dioxide); however, there are also other commercially available mixed-gas combinations that can be used.

Wire Electrodes

A solid wire electrode, like Hobart's HB-28, requires use of a shielding gas to protect the molten weld puddle from impurities in the atmosphere, namely oxygen and nitrogen. As a result, no slag is produced. Common shielding gases for solid wire applications include 100% CO₂, (carbon dioxide) and 75% Ar/25% CO₂ (75% argon and 25%

Helpful Hint #8

Refer to the wire manufacturer's recommendations for shielding gas or see page 19 for how a specific shielding gas can enhance the welding process.

Flux-cored wires, such as Hobart's Fabshield 21B, are different from solid wires in that they have a center core of flux. This flux, when melted, creates a shielding gas to protect the molten weld puddle from oxygen and other

impurities; hence, no external shielding gas is required.* Any impurities in the weld are brought to the weld surface in the form of a thin covering called slag which should be removed with either a chipping hammer or chisel and cleaned off with a wire brush.

**Flux-cored wires that do not require shielding gas are called self-shielded wires; however, there are flux-cored wires that do not require use of a shielding gas, but these are primarily used for industrial applications in which the shielding gas helps the weld metal attain certain characteristics.*

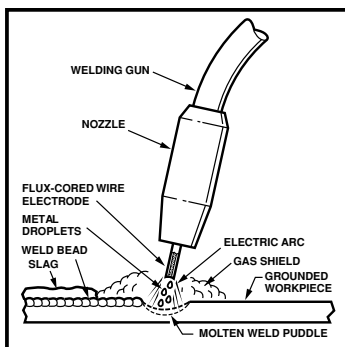

Equipment and Tools

In wire welding, the equipment and tools that are required are:

- Power source welding machine – complete with welding gun and gun cable assembly; automatic wire feeder and control system; and ground cable and clamp
- Shielding gas system* that consists of a gas cylinder, regulator, flowmeter and gas hose
- Wire cutters, chipping hammer or chisel, and wire brush
- Proper clothing including helmet and gloves



Automotive repair using the Millermatic 211 and HB-28 solid wire

**Not required for Fabshield 21B.*

Helpful Hint #9

While welding, be sure to keep your gun cable as straight as possible to avoid erratic arc behavior.

Techniques

To produce a good quality weld, it is important to master the following wire welding techniques. However, before starting any welding project, make sure the workpiece – the item you are welding – is as clean as possible. Use a clean cloth, wire brush or sandpaper to remove rust, dirt, paint, grease, oil or any other contaminant. Do not use cleaning solvents because you run the risk of an explosion or fire, or illness from toxic vapors.

Wire Polarity

Be sure to check the wire manufacturer's instructions for wire polarity and set the power source accordingly. If the power source is not set for the proper polarity, you may end up with a poor quality weld.



Shop repairs made easily with Hobart's HB-28 solid wire

HB-28 solid wire requires the power source to be set for DCEP (DC current, electrode positive) or else the weld may lack penetration and have poor appearance due to excessive spatter.

Fabshield 21B wire requires the power source to be set for DCEN (DC current, electrode negative); otherwise, the weld may be porous and produce slag that is difficult to remove.

Wire Feed Speed and Voltage

Select the proper wire feed speed (amperage) and voltage based on the specifications of your wire electrode.

Sometimes, you may need to “fine tune” the settings. The best way to check wire feed speed and voltage settings is to perform some test welds on scrap metal and check the weld. Be sure that you...

do not use wire feed speed that is set too fast as it will cause too much metal to be deposited, wasting filler metal or resulting in possible burn-through;

do not use wire feed speed that is set too low because it will produce a weld that doesn't penetrate or fill the joint properly and may cause the wire to “burn back” or melt at the tip;

do not use voltage that is too high because it will create a flatter, wider weld bead that is porous, plus excessive spatter. In addition, high voltage can cause undercutting, a groove melted into the workpiece that doesn't get properly filled with weld metal;

do not use voltage that is set too low or the weld bead will be narrow and lack proper penetration and fusion.

Helpful Hint #10

Listen to the arc for an indication of whether or not you are welding properly. A good arc sound is one that is consistent and sounds like bacon frying. If you hear excessive popping and cracking, it's a good indication that the electrode is sticking too far out of the gun or the wire feed speed is too fast.

Initiating an Arc

To initiate an arc, simply position the gun close to the weld joint and depress the trigger.

Once the arc is initiated, pay close attention to the following key factors in achieving a good quality weld:

- electrode stick-out
- electrode angles
- welding gun manipulation
- travel speed

Electrode Stick-Out

Electrode stick-out is the length of unmelted wire coming out of the contact tip of the welding gun. It affects the amount of amperage drawn by the wire and is important because it can affect the outcome of your weld. Determining how much stick-out to use depends on the diameter size of your wire.

For instance, a good guideline to follow is: for .024" and .030" wire, use 3/8"-1/2" stick-out; for .035" and .045" wire, use 1/2"-5/8".

You can make slight adjustments to the stick-out to "fine-tune" the amperage for the result you want. For instance, by lengthening the stick-out, you slightly decrease the amperage; by shortening the stick-out, you slightly increase the amperage.

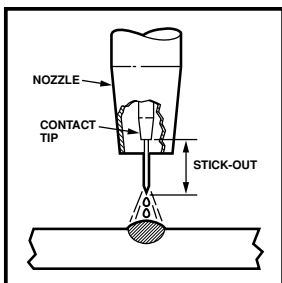

Electrode Angles

In wire welding, you want to be sure that you properly position the wire electrode over the weld joint for maximum coverage. This involves paying special attention to the work angle and the travel angle.

The *work angle* is the angle at which the wire is pointing at the weld joint. For lap and T-welds, the work angle is 45°, for butt welds, it is 90°.

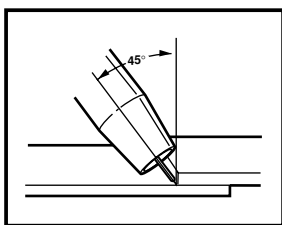

Lap weld with 45° work angle

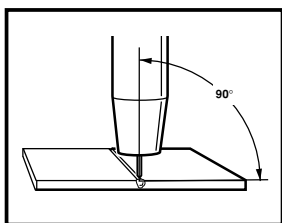

Butt weld with 90° work angle

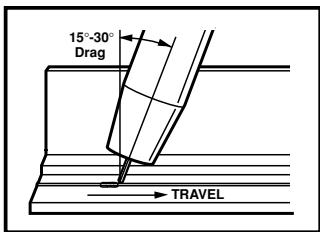

15°-30° drag level angle

The *travel angle* is the angle of the wire as it travels along the weld path. For most wire welding applications, this angle is 15-30°.

For home and farm welding applications, the travel angle most commonly used is called a *drag angle*, when the electrode is pointing in a direction that's opposite the arc travel.

Helpful Hint #11

While welding, be sure to keep your gun cable as straight as possible to avoid erratic arc behavior.

Welding Gun Manipulation

How you manipulate the welding gun, therefore the electrode, is another key factor in producing a good quality weld.

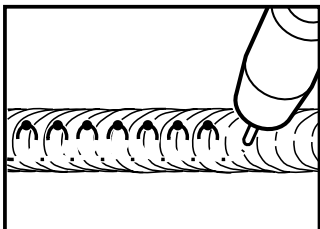

Oval pattern for lap and T-welds

For lap and T-welds, manipulating the gun to create a series of small ovals provides good welding coverage. Be careful not to move too far back into the weld puddle or else fusion problems may occur.

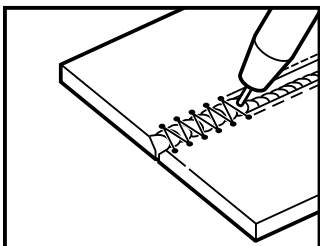

"Z" pattern for butt joints

For butt joints, manipulate the gun so that the electrode moves in a 'Z' pattern while traveling along the workpiece. This pattern is most effective because it produces a flatter weld, spreading the molten weld puddle evenly across the joint.

Travel Speed

Travel speed is the rate at which you weld. As you weld, watch the molten weld puddle and listen to the arc for evidence of traveling too fast or too slow. Moving at a high travel speed or too fast causes insufficient penetration, plus you'll hear popping sounds as the wire comes into contact with the cold metal just ahead of the puddle. Welding at low travel speeds, or moving too slow, will cause the weld metal to pile up, resulting in poor fusion. (See pages 20 and 21 for examples of good and bad welds.)

Shielding Gases and Their Welding Advantages

100% CO₂

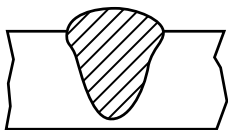

provides broad penetration and reduces the chance of porosity

75-80% Ar/20-25% CO₂

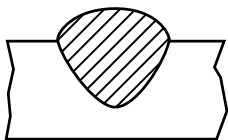

allows high welding speeds without burn-through, and with minimal distortion and spatter

For more than 80 years, Hobart has dedicated itself to providing the technology, the expertise and the commitment to quality required to keep pace with an evolving welding industry. And it's because of this dedication that welders choose Hobart first... because they know that with every Hobart product they purchase, they'll get complete customer satisfaction.

Recognized worldwide as a leading manufacturer of high-quality welding products, Hobart is headquartered in Troy, Ohio, where it shares its home with the Hobart Institute of Welding Technology. Hobart's presence in the industry is further strengthened by its nationwide network of handpicked distributors who stand ready to help customers with a wide array of Hobart welding solutions.

*For more information about Hobart welding products or to receive a Hobart Full-line Catalog, visit us on the web at **www.hobartbrothers.com** or contact your local Hobart distributor.*

EXAMPLES OF GOOD AND BAD WIRE WELDS

GOOD WELD
Proper wire feed speed, voltage and travel speed

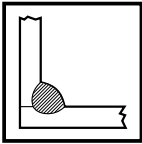

CROSS-SECTION



Weld Face

Smooth and well-formed

Uniform contour

Good penetration and fusion

BAD WELD
Wire feed speed too low



CROSS-SECTION



Weld Face

Wide and flat with excessive spatter

Very irregular contour

Undercutting along edges

BAD WELD
Wire feed speed too high

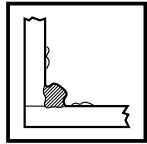

CROSS-SECTION



Weld Face

Narrow and convex

Irregular contour

Slag may be difficult to remove

BAD WELD
Travel Speed
too fast

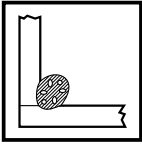

CROSS-SECTION



Weld Face

Narrow and convex

Irregular contour

Extremely porous

BAD WELD
Travel Speed
too slow

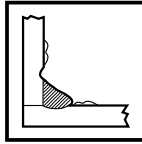

CROSS-SECTION



Weld Face

Excessively wide and flat with spatter

Irregular contour

Poor penetration along edges



HobartBrothers.com

Hobart Brothers Company

Troy, OH 45373 USA

Phone 800.424.1543

Fax 800.541.6607

International Fax 937.332.4094

www.hobartbrothers.com

